

Schleuderschiene 4300

Aluschiene

System 4300

SCHIENE 4320

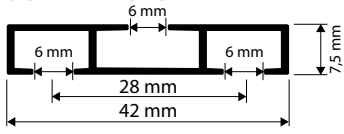

SCHIENE 4340

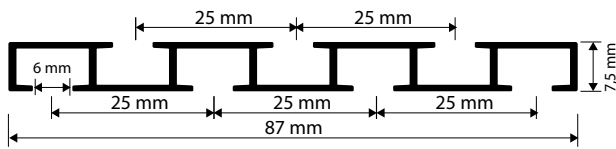

PRODUKTMERKMALE

- sehr flaches Aluminiumprofil
- Schiene als 1- oder 2- bzw. 3- oder 4-Lauf verwendbar
- Deckenmontage
- Spurbreite 6 mm
- Lagerlänge 6 m

LIEFERBARE FARBEN



weiß (RAL 9016)



silber (RAL 9006)

BELASTUNGSTABELLE

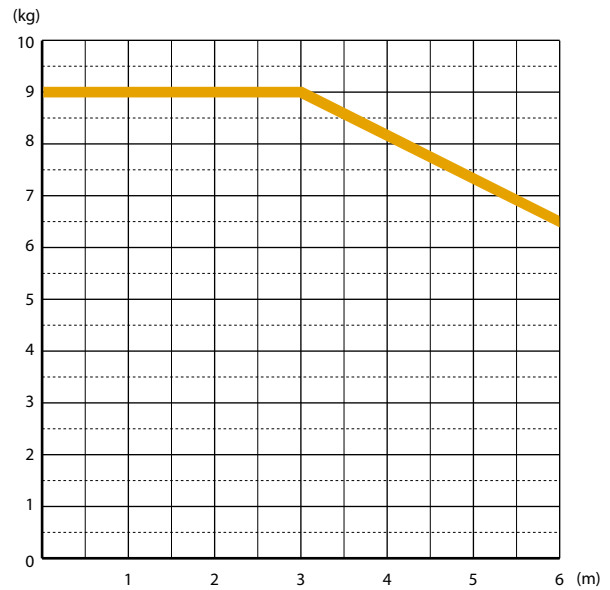

Bitte verwenden Sie bei schweren Vorhängen **Objektgleiter**.

STANDARDKOMPONENTEN



GLEITER WÄHLBAR



Genauere Bezeichnung von Standardkomponenten und Gleitern, sowie weitere Gleiter finden Sie unter **Zubehör**.

MONTAGEMÖGLICHKEITEN

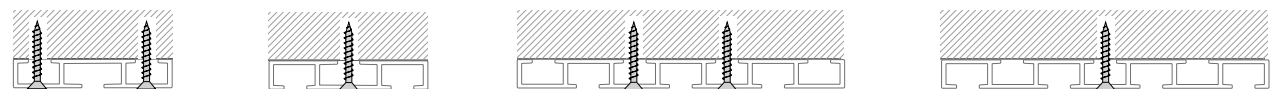

RETOURENBIEGUNG



Retourenbiegung für 4320

mögliche Radien: **20 cm**

BIEGUNG



horizontale Biegung für 4320

mögliche Radien: **20 cm, ab 40 cm jeder Radius**



vertikale Biegung für 4320

mögliche Radien: **20 cm, ab 40 cm jeder Radius**

RETOURENBIEGUNG

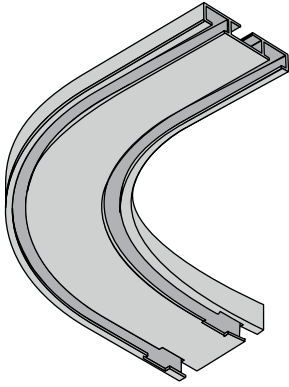

Modell 4320

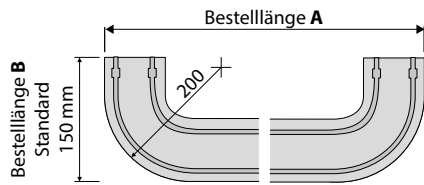

GEHRUNGSSCHNITT

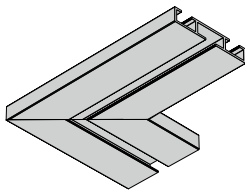

Modell 4320 – 1-Lauf

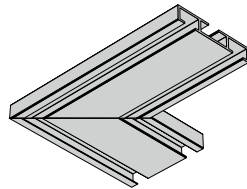

Modell 4320 – 2-Lauf

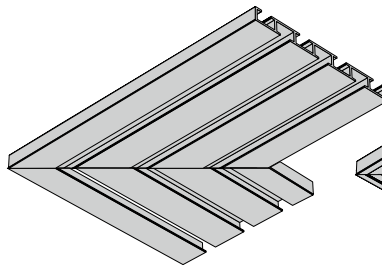

Modell 4340 – 3-Lauf

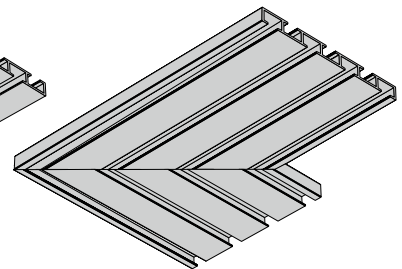

Modell 4340 – 4-Lauf

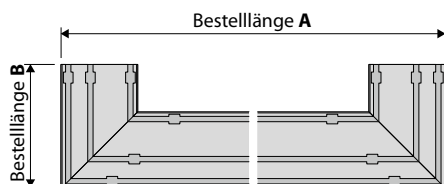

Gehrungsschnitt 4320 inkl. 1 Eckverbinder
Gehrungsschnitt 4340 inkl. 2 Eckverbinder

Schleuderschiene 4400

Aluschienen

System 4400

SCHIENE 4410

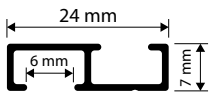

SCHIENE 4420

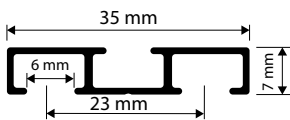

SCHIENE 4425

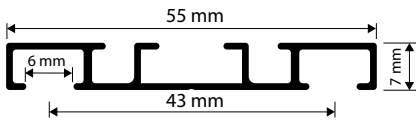

SCHIENE 4430

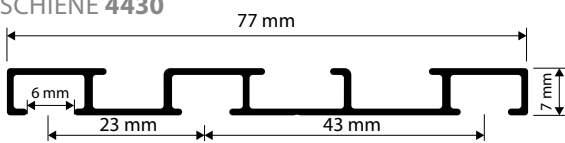

BELASTUNGSTABELLE

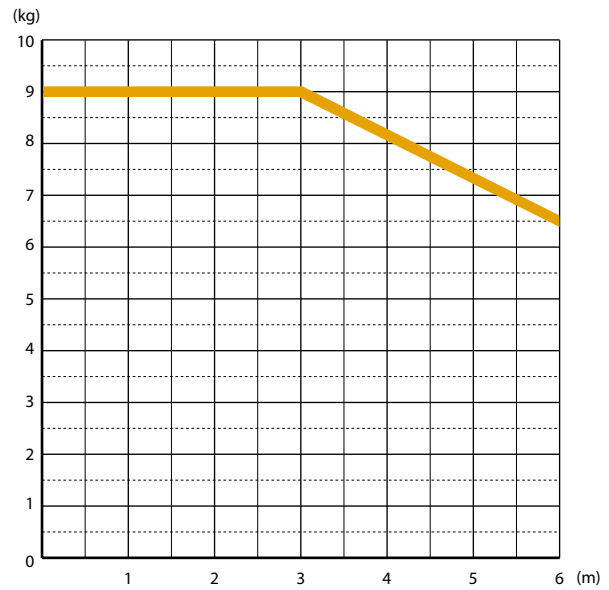

PRODUKTMERKMALE

- sehr flaches Aluminiumprofil
- verschiedene Laufvarianten in gleicher Optik
- objektgeeignet
- für Deckenmontage
- Spurbreite 6 mm
- Lagerlänge 6 m



Bitte verwenden Sie bei schweren Vorhängen **Objektgleiter**.

LIEFERBARE FARBEN



weiß (RAL 9016)



silber (eloxiert)

STANDARDKOMPONENTEN

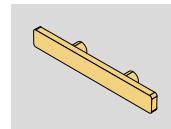
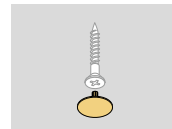
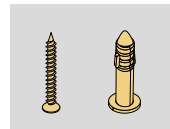
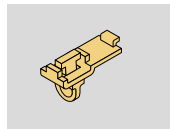
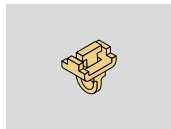
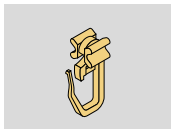

GLEITER WÄHLBAR (ohne Aufpreis)

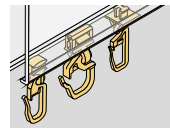

Genauere Bezeichnung von Standardkomponenten und Gleitern, sowie weitere Gleiter finden Sie unter **Zubehör**.

MONTAGEMÖGLICHKEITEN

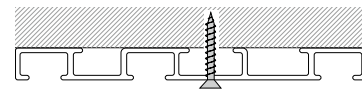
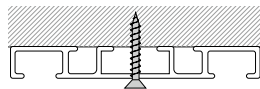
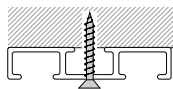
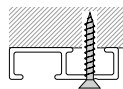

RETOURENBIEGUNG



mögliche Radien: **10 cm, 15 cm** (bitte Biegeausführung beachten)

BIEGUNG



horizontale Biegung

mögliche Radien: **10 cm, 15 cm, ab 40 cm** jeder Radius (bitte Biegeausführung beachten)



vertikale Biegung

für 4410 und 4420
mögliche Radien: **20 cm, ab 40 cm** jeder Radius

RETOURENBIEGUNG

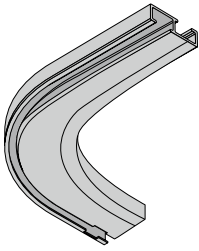

Modell 4410

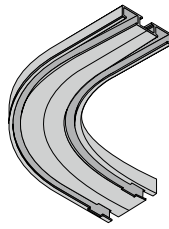

Modell 4420

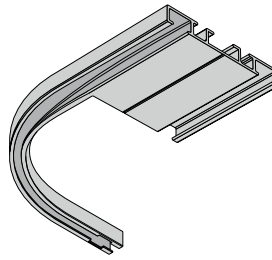

Modell 4425

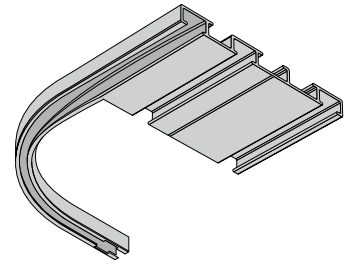

Modell 4430

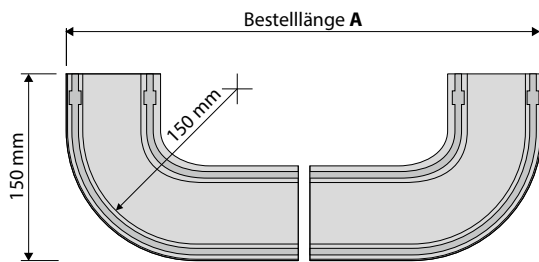

Retourenbiegung 4410/4420

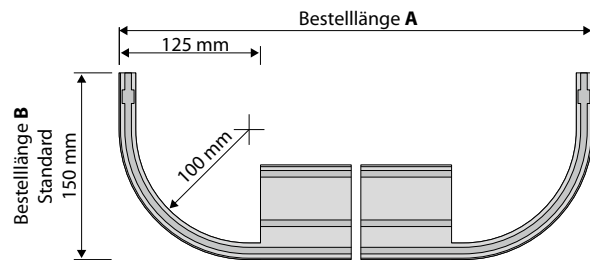

Retourenbiegung 4425/4430

GEHRUNGSSCHNITT

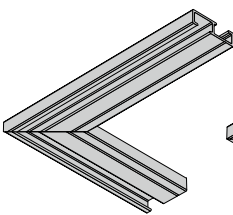

Modell 4410

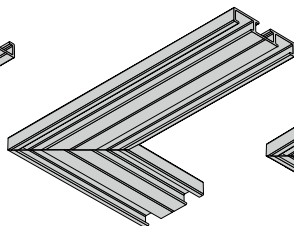

Modell 4420

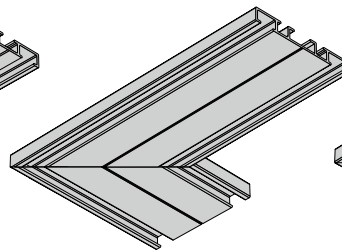

Modell 4425

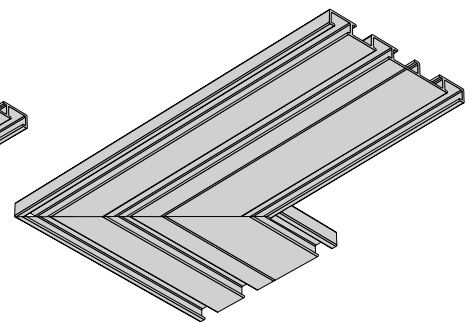

Modell 4430

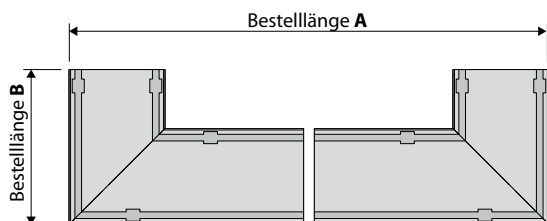

Gehrungsschnitt inkl. 1 Eckverbinder

Schleuderschiene 4500

Aluschiene

System 4500

SCHIENE 4520

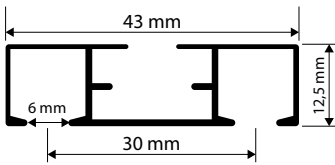

SCHIENE 4525

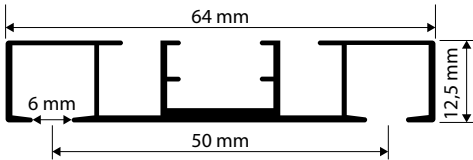

SCHIENE 4530

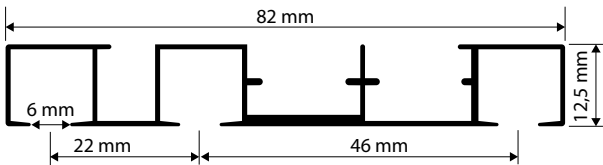

BELASTUNGSTABELLE

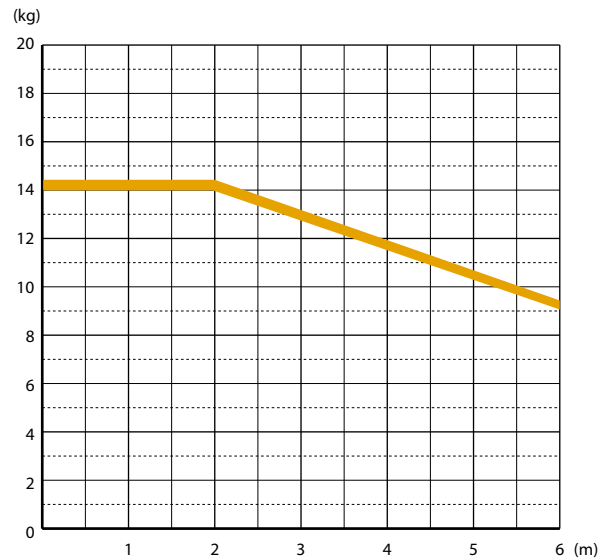

PRODUKTMERKMALE

- flache Deckenschiene aus Aluminium
- objektgeeignet
- Deckenmontage
- Spurbreite 6 mm
- Lagerlänge 6 m



Bitte verwenden Sie bei schweren Vorhängen **Rollen** bzw. **Objektgleiter**.

LIEFERBARE FARBEN



weiß (RAL 9016)



silber (eloxiert)

STANDARDBKOMPONENTEN



GLEITER WÄHLBAR



Genauere Bezeichnung von Standardkomponenten und Gleitern, sowie weitere Gleiter finden Sie unter **Zubehör**.

MONTAGEMÖGLICHKEITEN

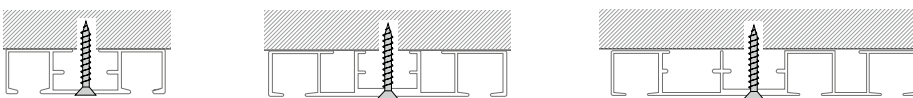

RETOURENBIEGUNG



mögliche Radien: **10 cm**
(bitte Biegeausführung beachten)

RETOURENBIEGUNG

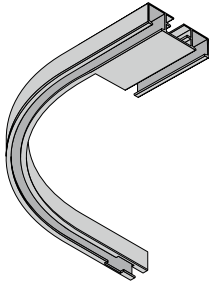

Modell 4520

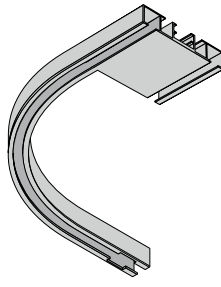

Modell 4525

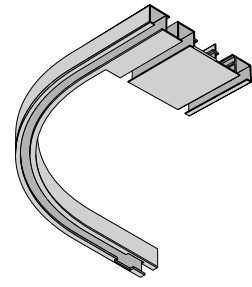

Modell 4530

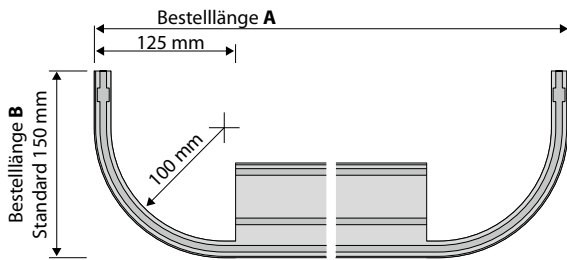

GEHRUNGSSCHNITT

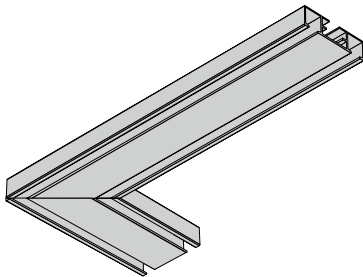

Modell 4520

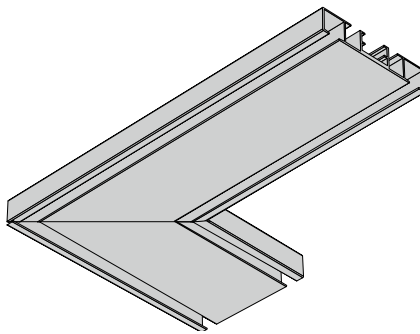

Modell 4525

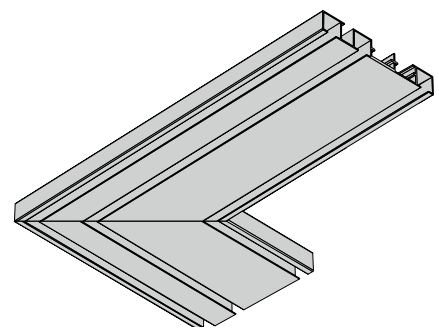

Modell 4530

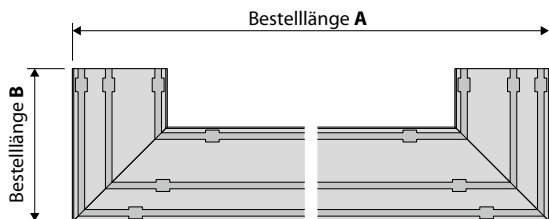

Schleuderschiene 4600

Aluschiene

System 4600

SCHIENE 4620

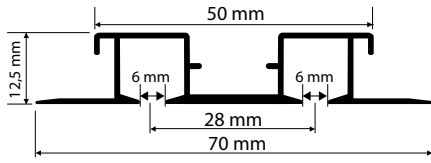

SCHIENE 4625

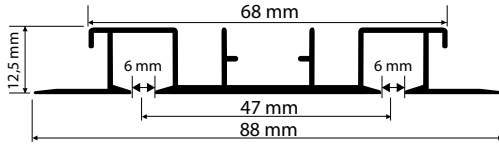

SCHIENE 4630

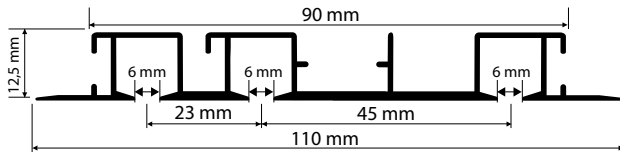

BELASTUNGSTABELLE

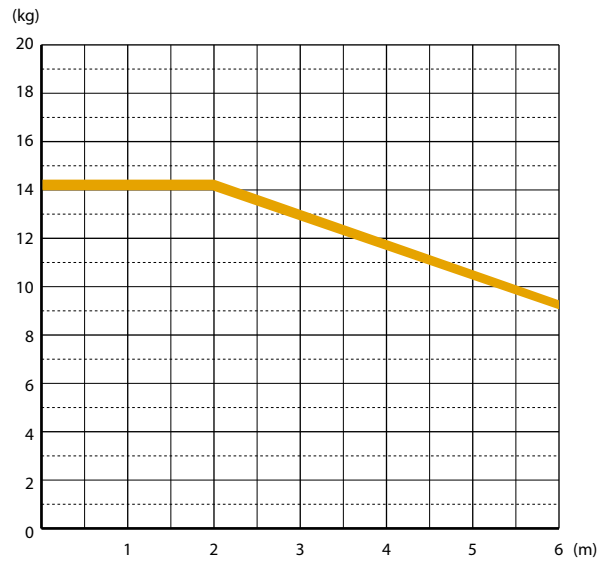

PRODUKTMERKMALE

- objektgeeignetes Einbauprofil aus Aluminium
- Einbau in abgehängten Decken
- Spurbreite 6 mm
- Lagerlänge 6 m



Bitte verwenden Sie bei schweren Vorhängen **Rollen bzw. Objektgleiter**.

LIEFERBARE FARBEN



weiß (RAL 9016)

STANDARDBEWEISER

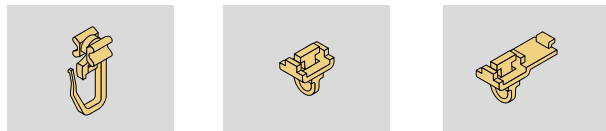

GLEITER WÄHLBAR



Genauere Bezeichnung von Standardkomponenten und Gleitern, sowie weitere Gleiter finden Sie unter **Zubehör**.

MONTAGEMÖGLICHKEITEN

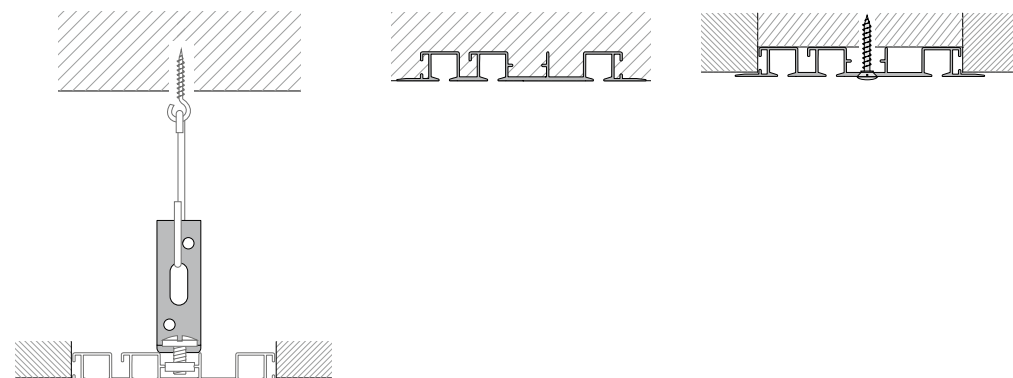

System 4850

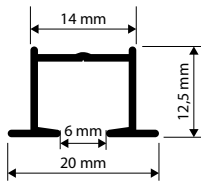

PRODUKTMERKMALE

- elegantes Nutprofil für Holzunterkonstruktion sowie Gipskarton mit mind. 30 mm Stärke
- Deckenmontage
- Verwendung von Rollen möglich
- Spurbreite 6 mm
- Lagerlänge 6 m
- vorgebohrt alle 15 cm

LIEFERBARE FARBEN



weiß (RAL 9016)

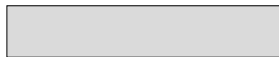

silber (eloxiert)

STANDARDKOMPONENTEN

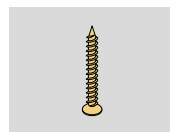
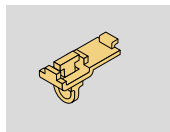
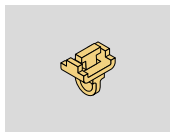
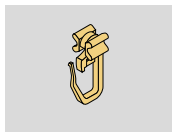

GLEITER WÄHLBAR

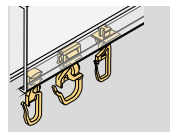

Genauere Bezeichnung von Standardkomponenten und Gleitern, sowie weitere Gleiter finden Sie unter **Zubehör**.

BELASTUNGSTABELLE



MONTAGEMÖGLICHKEITEN

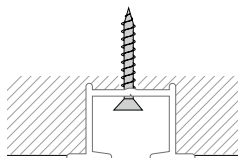

BIEGUNG



horizontale Biegung

mögliche Radien: **ab 40 cm jeder Radius**